



NANDHA ENGINEERING COLLEGE

(AUTONOMOUS)

(Approved by AICTE, New Delhi and Affiliated to Anna University, Chennai)

Perundurai, Erode - 638052, Tamil Nadu, India.



Email: principal@nandhaengg.org

Website: www.nandhaengg.org Phone: 04294-225585

7.1 Institutional Values and Social Responsibilities

7.1.4

Water conservation facilities available in the Institution

S.No	Description	Page No
1.	Rain water harvesting	2
2.	Open well recharge	4
3.	Construction of tanks and bunds	7
4.	Waste water recycling	13
5.	Layout of water distribution system	15
6.	Location of water bodies	18
7.	Video Link for Rain Water Harvesting	
8.	Video Link for Waste Water Recycling	
9.	Video Link of Open well	



NANDHA ENGINEERING COLLEGE

(AUTONOMOUS)

**(Approved by AICTE, New Delhi and Affiliated to Anna University, Chennai)
Perundurai, Erode - 638052, Tamil Nadu, India.**

Email: principal@nandhaengg.org

Website: www.nandhaengg.org Phone: 04294-225585

Rain Water Harvesting



NANDHA ENGINEERING COLLEGE

(AUTONOMOUS)

(Approved by AICTE, New Delhi and Affiliated to Anna University, Chennai)

Perundurai, Erode - 638052, Tamil Nadu, India.

Email: principal@nandhaengg.org

Website: www.nandhaengg.org Phone: 04294-225585

Rain Water Harvesting

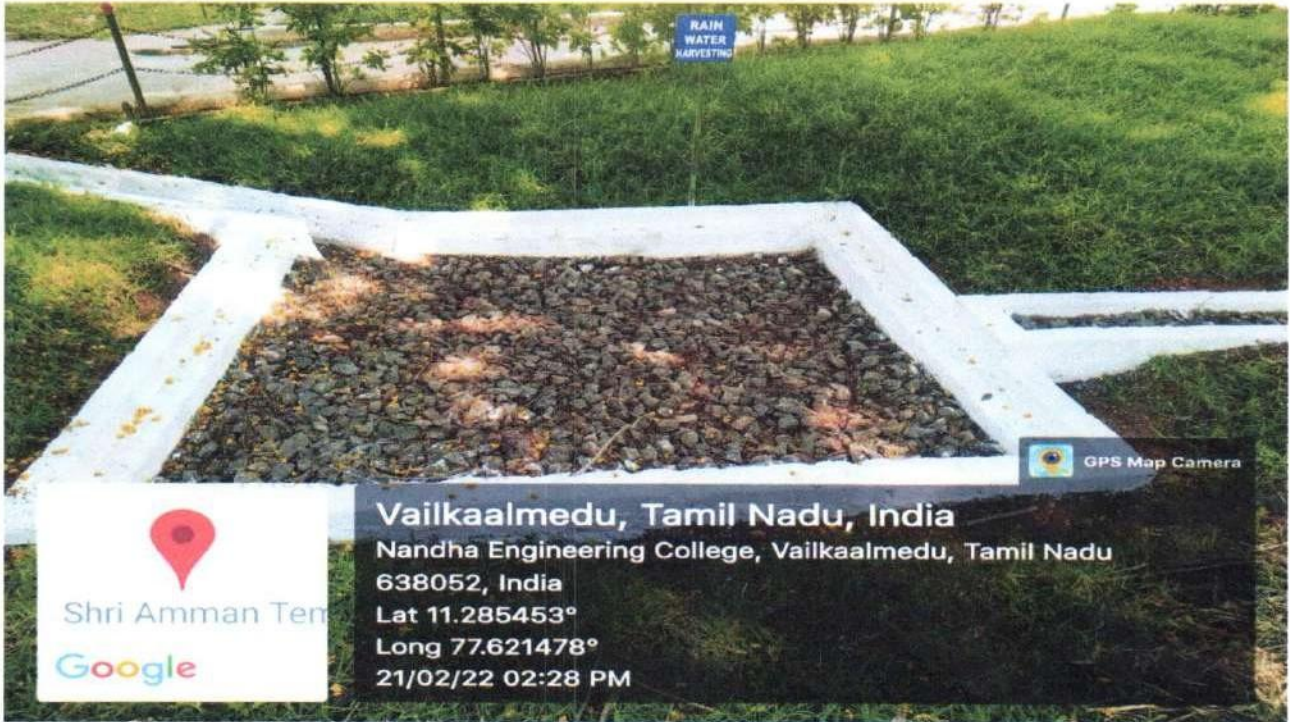

N. Anand
PRINCIPAL
Nandha Engineering College
(Autonomous)
Erode - 638 052.



NANDHA ENGINEERING COLLEGE

(AUTONOMOUS)

**(Approved by AICTE, New Delhi and Affiliated to Anna University, Chennai)
Perundurai, Erode - 638052, Tamil Nadu, India.**

Email: principal@nandhaengg.org

Website: www.nandhaengg.org Phone: 04294-225585

Open well recharge



NANDHA ENGINEERING COLLEGE

(AUTONOMOUS)

(Approved by AICTE, New Delhi and Affiliated to Anna University, Chennai)
Perundurai, Erode - 638052, Tamil Nadu, India.

Email: principal@nandhaengg.org

Website: www.nandhaengg.org Phone: 04294-225585

NEC WELL

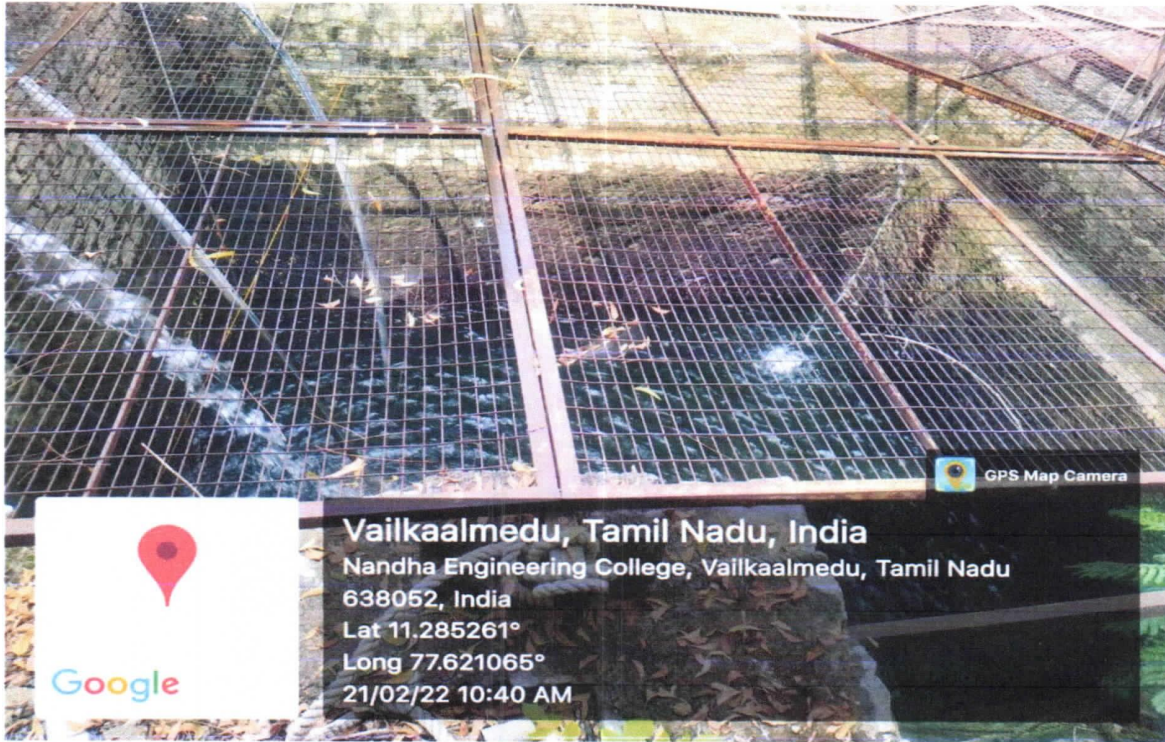

PRINCIPAL
Nandha Engineering College
(Autonomous)
Erode - 638 052.



NANDHA ENGINEERING COLLEGE

(AUTONOMOUS)

(Approved by AICTE, New Delhi and Affiliated to Anna University, Chennai)

Perundurai, Erode - 638052, Tamil Nadu, India.

Email: principal@nandhaengg.org

Website: www.nandhaengg.org Phone: 04294-225585

Construction of tanks and bunds



NANDHA ENGINEERING COLLEGE

(AUTONOMOUS)

(Approved by AICTE, New Delhi and Affiliated to Anna University, Chennai)

Perundurai, Erode - 638052, Tamil Nadu, India.

Email: principal@nandhaengg.org

Website: www.nandhaengg.org Phone: 04294-225585

Block 2 – TANK 1

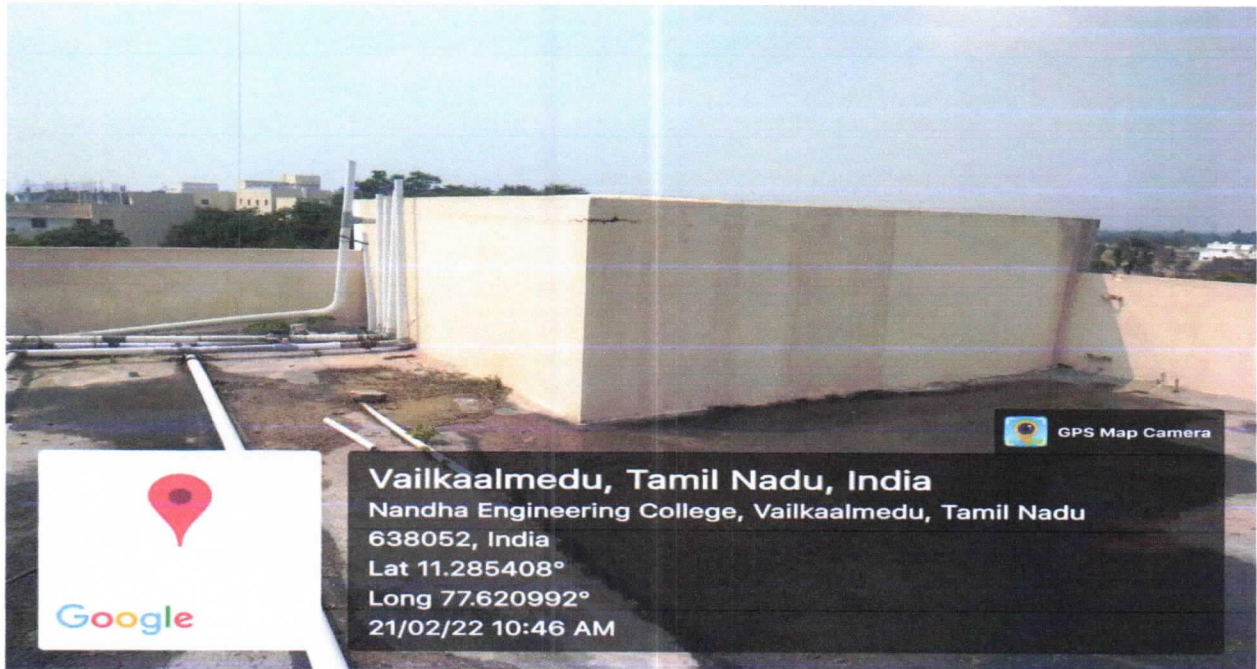

Block 3 – TANK 2

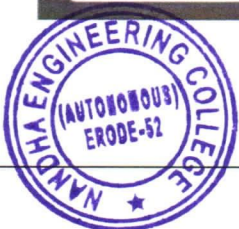
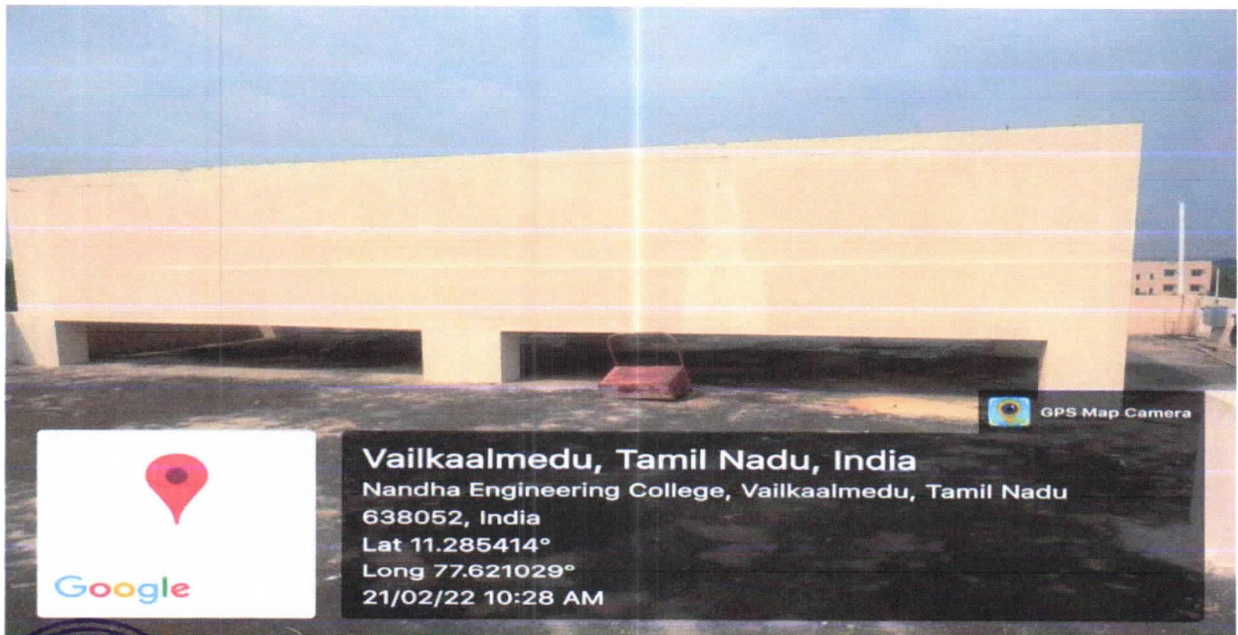

PRINCIPAL
Nandha Engineering College
(Autonomous)
Erode - 638 052.



NANDHA ENGINEERING COLLEGE

(AUTONOMOUS)

(Approved by AICTE, New Delhi and Affiliated to Anna University, Chennai)

Perundurai, Erode - 638052, Tamil Nadu, India.

Email: principal@nandhaengg.org

Website: www.nandhaengg.org Phone: 04294-225585

Waste Water Recycling



NANDHA ENGINEERING COLLEGE

(AUTONOMOUS)

(Approved by AICTE, New Delhi and Affiliated to Anna University, Chennai)

Perundurai, Erode - 638052, Tamil Nadu, India.

Email: principal@nandhaengg.org

Website: www.nandhaengg.org Phone: 04294-225585

Waste Water Recycling



N. A.
PRINCIPAL
Nandha Engineering College
(Autonomous)
Erode - 638 052



NANDHA ENGINEERING COLLEGE

(AUTONOMOUS)

**(Approved by AICTE, New Delhi and Affiliated to Anna University, Chennai)
Perundurai, Erode - 638052, Tamil Nadu, India.**

Email: principal@nandhaengg.org

Website: www.nandhaengg.org Phone: 04294-225585

Layout of water distribution system



NANDHA ENGINEERING COLLEGE

(AUTONOMOUS)

(Approved by AICTE, New Delhi and Affiliated to Anna University, Chennai)

Perundurai, Erode - 638052, Tamil Nadu, India.

Email: principal@nandhaengg.org

Website: www.nandhaengg.org Phone: 04294-225585

Layout of Water Distribution System

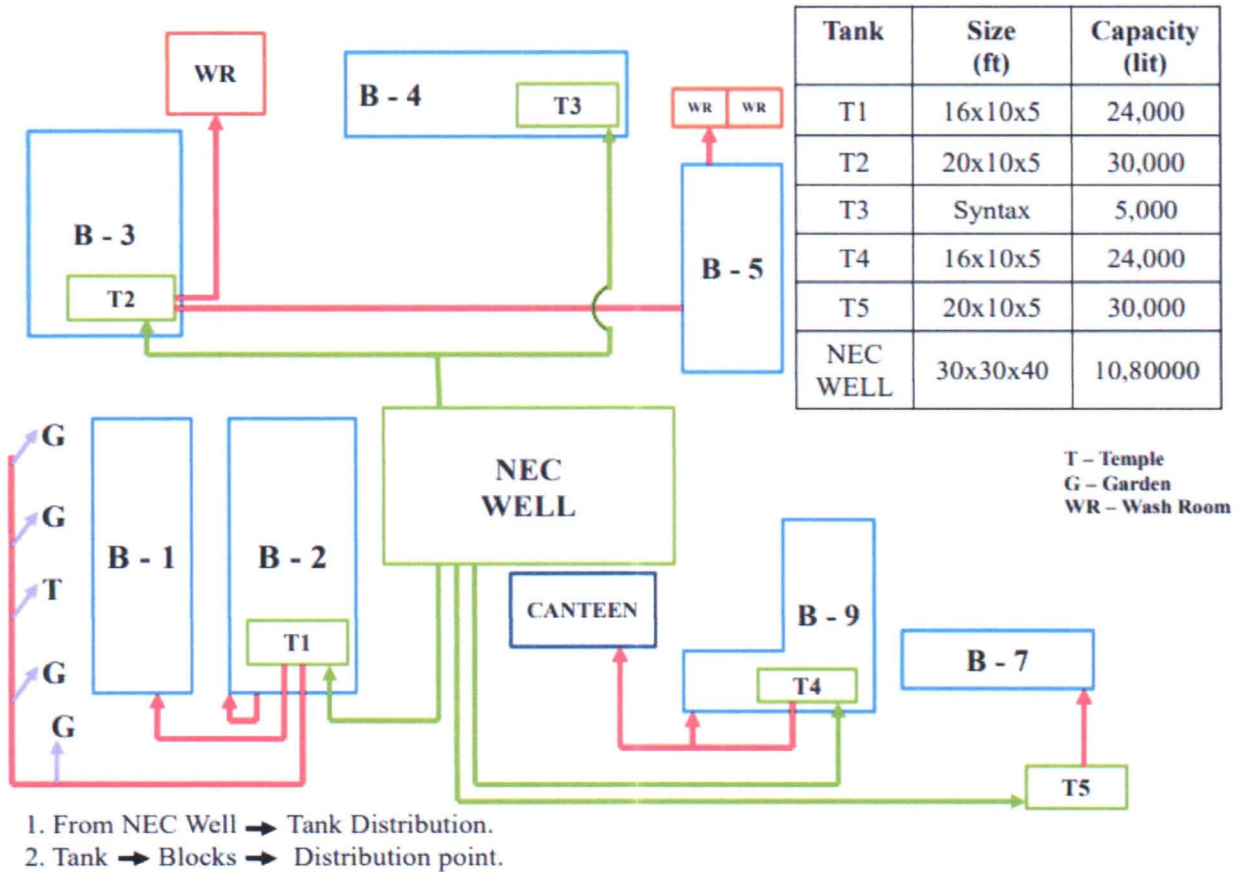

(Handwritten Signature)

PRINCIPAL
Nandha Engineering College
(Autonomous)
Erode - 638 052.



NANDHA ENGINEERING COLLEGE

(AUTONOMOUS)

(Approved by AICTE, New Delhi and Affiliated to Anna University, Chennai)
Perundurai, Erode - 638052, Tamil Nadu, India.

Email: principal@nandhaengg.org

Website: www.nandhaengg.org Phone: 04294-225585

WATER SOURCES AND DISTRIBUTION

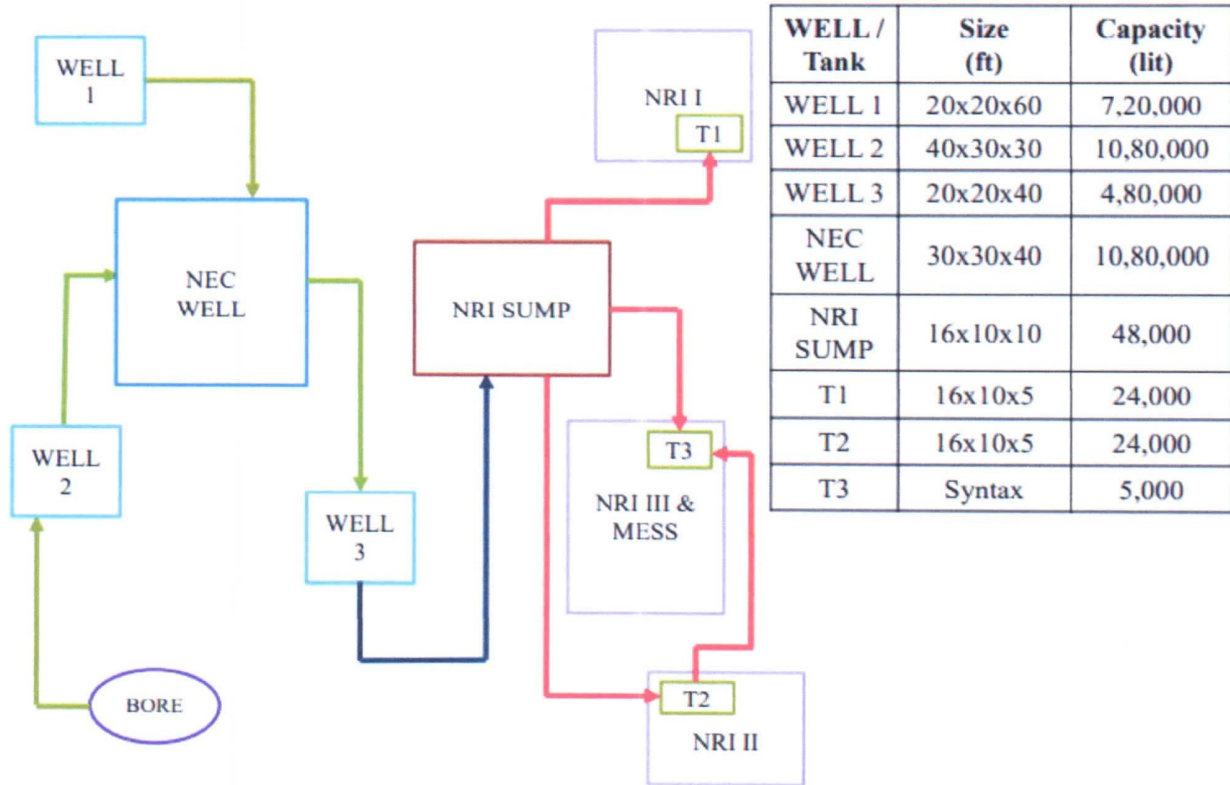

WELL / Tank	Size (ft)	Capacity (lit)
WELL 1	20x20x60	7,20,000
WELL 2	40x30x30	10,80,000
WELL 3	20x20x40	4,80,000
NEC WELL	30x30x40	10,80,000
NRI SUMP	16x10x10	48,000
T1	16x10x5	24,000
T2	16x10x5	24,000
T3	Syntax	5,000



PRINCIPAL
Nandha Engineering College
(Autonomous)
Erode - 638 052.



NANDHA ENGINEERING COLLEGE

(AUTONOMOUS)

**(Approved by AICTE, New Delhi and Affiliated to Anna University, Chennai)
Perundurai, Erode - 638052, Tamil Nadu, India.**

Email: principal@nandhaengg.org

Website: www.nandhaengg.org Phone: 04294-225585

Location of Water Bodies



NANDHA ENGINEERING COLLEGE

(AUTONOMOUS)

(Approved by AICTE, New Delhi and Affiliated to Anna University, Chennai)

Perundurai, Erode - 638052, Tamil Nadu, India.

Email: principal@nandhaengg.org

Website: www.nandhaengg.org Phone: 04294-225585

Location of Water Bodies

S.No	Name	Location	Capacity (lit)
1	NEC Well	Near to Canteen	10,80,000
2	Well 1	Near to Outside the campus	7,20,000
3	Well 2	Near to Outside the campus	4,80,000
4	Tank 1	Block II	24,000
5	Tank 2	Block III	30,000
6	Tank 3	Block IV	5,000
7	Tank 4	Block IX	24,000
8	Tank 5	Opposite to Block 7	30,000
9	Tank 1	NRI – I	24,000
10	Tank 2	NRI – II	24,000
11	Tank 3	NRI – III	5,000

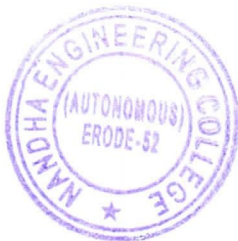

PRINCIPAL
Nandha Engineering College
(Autonomous)
Erode - 638 052.



NANDHA ENGINEERING COLLEGE

(AUTONOMOUS)

(Approved by AICTE, New Delhi and Affiliated to Anna University, Chennai)
Perundurai, Erode - 638052, Tamil Nadu, India.

Email: principal@nandhaengg.org

Website: www.nandhaengg.org Phone: 04294-225585

RO Plant I - Block III (3rd Floor)



[Handwritten Signature]
PRINCIPAL
Nandha Engineering College
(Autonomous)
Erode - 638 052.



NANDHA ENGINEERING COLLEGE

(AUTONOMOUS)

(Approved by AICTE, New Delhi and Affiliated to Anna University, Chennai)

Perundurai, Erode - 638052, Tamil Nadu, India.

Email: principal@nandhaengg.org

Website: www.nandhaengg.org Phone: 04294-225585

RO Plant II – Block VI (Ground Floor)



Vailkaalmedu, Tamil Nadu, India
Nandha Engineering College, MCA and MBA Block,
Vailkaalmedu, Tamil Nadu 638052, India
Lat 11.284811°
Long 77.621474°
24/02/22 12:24 PM



[Handwritten Signature]
PRINCIPAL
Nandha Engineering College
(Autonomous)
Erode 638 052



NANDHA ENGINEERING COLLEGE

(AUTONOMOUS)

(Approved by AICTE, New Delhi and Affiliated to Anna University, Chennai)

Perundurai, Erode - 638052, Tamil Nadu, India.

Email: principal@nandhaengg.org

Website: www.nandhaengg.org Phone: 04294-225585

Video Links

Video Link for Rain Water Harvesting

<https://nandhaengg.org/wp-content/uploads/2022/03/Rain-water-Harvesting.mp4>



Video Link for Waste Water Recycling

<https://nandhaengg.org/wp-content/uploads/2022/03/STTP-Plant-Waste-Water-Recycling-1.mp4>



Video Link of Open well

<https://nandhaengg.org/wp-content/uploads/2022/03/Open-well.mp4>

